

Der
Kraft-Mayer

MAYER

TADANO FAUN

HK 50L

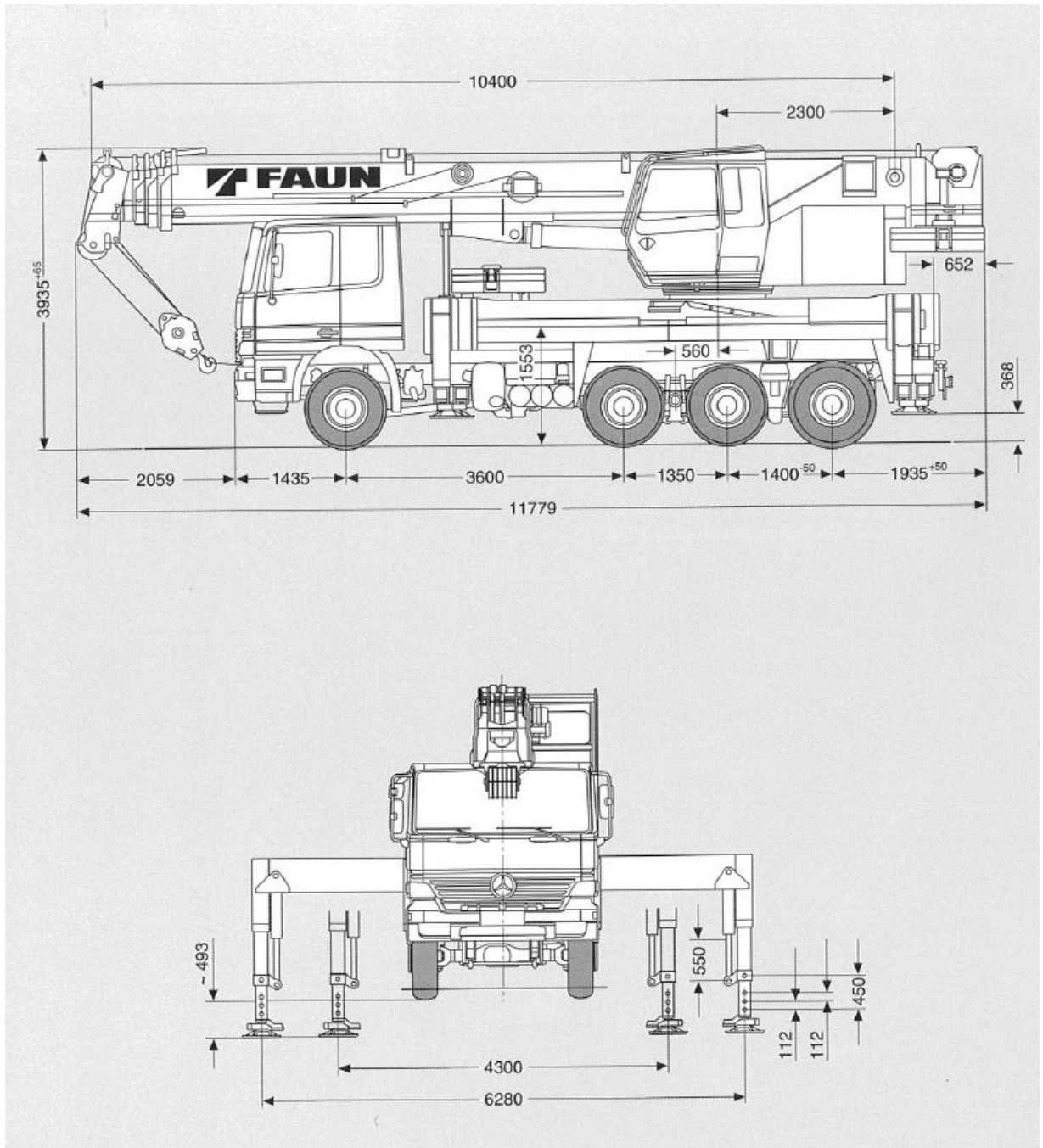

TADANO FAUN

HK 50L





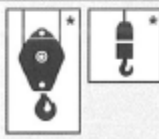

	Achse / Axle	1	2	3	4	Gesamtgewicht / Total weight
		3- (t)	8.6	11.9	11.9	10.5

* Abhängig vom Fahrgestell, incl. 9.9 t Gegengewicht, 12.5 t Hakenflasche, 6 t Hakengebüchel.
 * Depending on chassis, incl. 9.9 t counterweight, 12.5 t hook block, 6 t swivel hook.

	Traglast / Lifting capacity	Rollen / Sheaves	Stränge / Parts of line	Gewicht / Weight
	50 t	6	12	600 kg
	32 t	3	7	300 kg
	12.5 t	1	3	170 kg
	6 t	-	1	150 kg











							
km/h 	Alle diese Daten abhängig vom Fahrgestell This data depending on chassis						
km/h 							
							

V+ 	Stufenlos Infinitely variable	Seil Rope	Max. Seilzug Max. single line pull
	0 - 130 m/min für einfachen Strang single line	16 mm / 180 m	52 kN
	0 - 70 m/min für einfachen Strang single line	14 mm / 140 m	39 kN
	0 - 2 min ⁻¹		
	-2° - +82° ca. 33 s approx. 33 s		
	10.4 m - 40.2 m ca. 90 s approx. 90 s		

TADANO FAUN

HK 50L

   9.9t		DIN/ISO										
 m	10.4 m	14.1 m	17.8 m	25.3 m	32.7 m	36.5 m	40.2 m					
2.7	50.0											
3.0	44.1	30.0										
3.5	40.0	30.0	30.0									
4.0	36.6	30.0	29.0									
4.5	33.6	30.0	27.5									
5.0	31.1	30.0	26.2	17.0								
6.0	26.9	26.4	22.6	17.0	13.0							
7.0	23.6	23.1	20.0	15.8	13.0							
8.0	16.5	18.6	19.0	14.5	13.0	9.0	7.0					
9.0		15.1	15.5	13.3	12.0	8.8	7.0					
10.0		12.6	13.0	13.0	11.0	8.5	7.0					
11.0		10.7	12.3	11.9	10.1	8.3	7.0					
12.0			10.8	10.4	9.2	8.1	7.0					
14.0			8.4	8.7	7.5	7.6	6.5					
16.0				7.0	5.9	6.1	6.1					
18.0				5.7	5.1	4.9	5.1					
20.0				4.7	4.5	3.9	4.1					
22.0				3.9	4.0	3.2	3.4					
24.0					3.4	2.5	2.7					
26.0					2.9	2.0	2.2					
28.0					2.4	1.6	1.8					
30.0					2.1	1.2	1.4					
32.0						0.9	1.1					
34.0						0.6	0.8					
36.0							0.6					
 %	I 0	50	50	100	0	50	100	0	100	0	100	100
II	0	0	50	0	33	50	100	67	100	100	100	100
III	0	0	0	0	33	50	0	67	50	100	75	100
IV	0	0	0	0	33	50	0	67	50	100	75	100

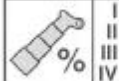
   9.9t		DIN/ISO								
 m	36.5 m + 9.0 m			40.2 m + 9.0 m			40.2 m + 16.0 m			
	5°	17°	30°	5°	17°	30°	5°	17°	30°	
10	4.80			3.80						
11	4.80			3.80						
12	4.80	4.00	3.00	3.80	3.40		2.20			
14	4.60	3.75	2.85	3.80	3.40	2.80	2.20	1.80		
16	4.40	3.45	2.65	3.70	3.25	2.70	2.20	1.80	1.30	
18	4.20	3.15	2.50	3.55	3.10	2.55	2.15	1.75	1.30	
20	3.75	2.90	2.35	3.45	3.00	2.45	2.05	1.65	1.25	
22	3.30	2.70	2.25	3.30	2.85	2.35	2.00	1.60	1.25	
24	2.65	2.55	2.15	2.75	2.70	2.25	1.90	1.50	1.20	
26	2.10	2.30	2.05	2.20	2.40	2.15	1.85	1.45	1.15	
28	1.65	1.80	1.90	1.75	1.90	2.00	1.70	1.35	1.15	
30	1.30	1.40	1.50	1.40	1.50	1.60	1.55	1.30	1.10	
32	0.95	1.05	1.10	1.05	1.15	1.25	1.45	1.25	1.05	
34	0.65	0.75	0.80	0.75	0.85	0.90	1.20	1.15	1.00	
36	0.40	0.45	0.50	0.50	0.55	0.60	0.95	1.10	1.00	
38							0.75	0.85	0.95	
40							0.50	0.65	0.75	
42								0.45	0.75	
44									0.50	
 %	I 100				100			100		
II	100				100			100		
III	75				100			100		
IV	75				100			100		

TADANO FAUN

HK 50L



DIN/ISO

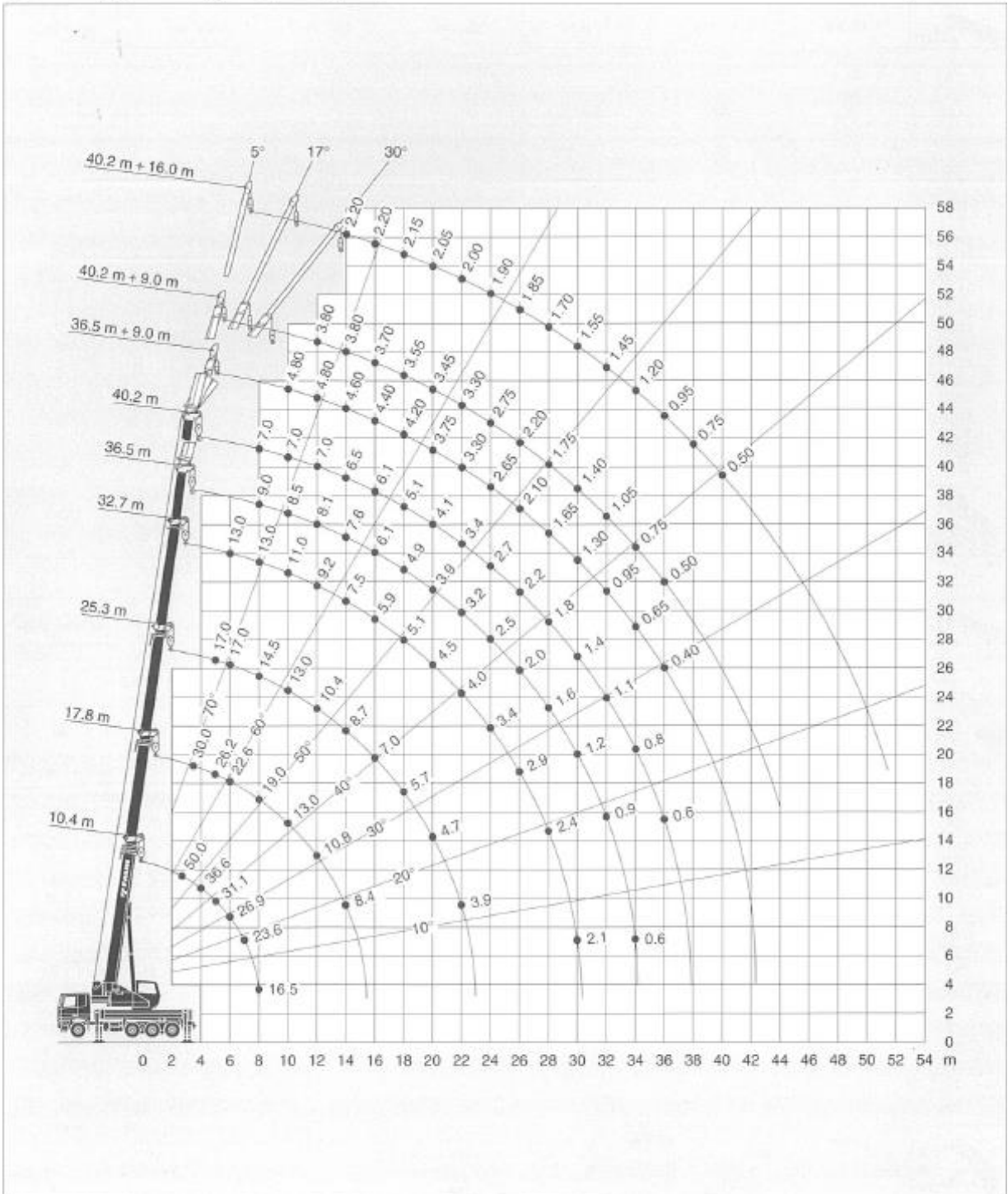

TADANO FAUN

HK 50L



DIN/ISO

